

5 Do not cover luminaire or driver with thermally insulating material **(A)**. It is recommended to allow a minimum of 50 mm clearance from combustible materials, as shown in **(B)**, **(C)** and **(D)**.

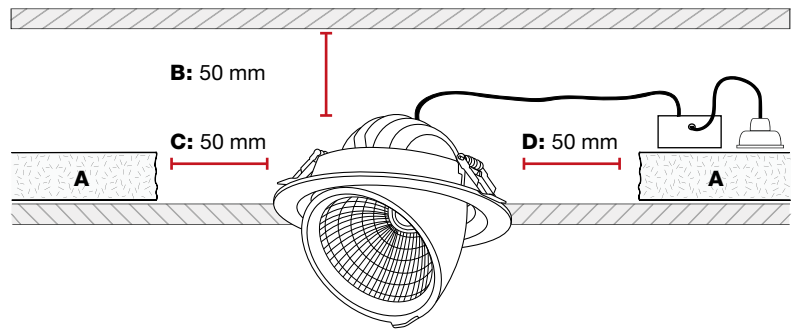

6 Restore power once installation has been completed.

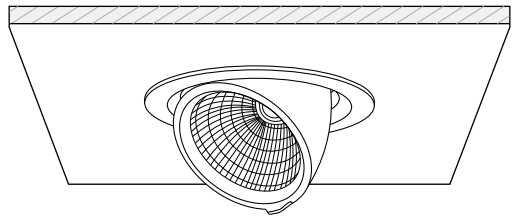

Maxiled XRS20 Recessed Downlight *Installation Guide*

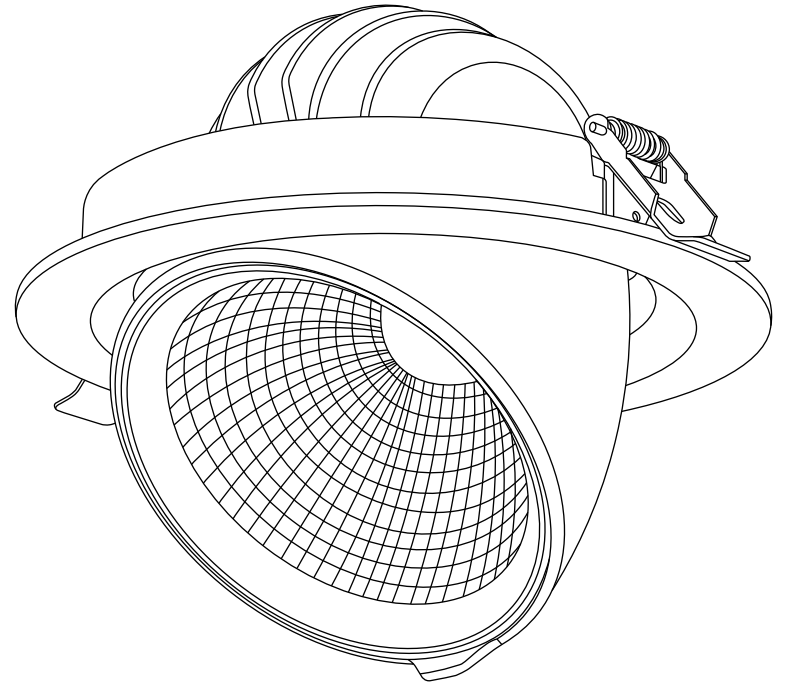

V1-11.03.2024 Product designs and technical data may be subject to change.

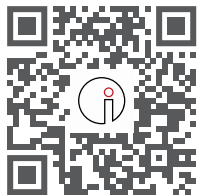

For warranty information, please visit

trendlighting.com.au/warranty

Important Safety Information

Please read these installation instructions carefully before installing this luminaire.

- This product must be installed by a licensed electrician in accordance with AS/NZS 3000 and local regulations.
- Isolate the mains power supply prior to installation.
- Only reconnect mains power after installation is completed.
- No part of the luminaire should be altered or modified.
- This product is not user serviceable.

Approvals

The RCM marking of this product applies to AS/NZS 4417.1 "Regulatory compliance mark (RCM) for electrical and electronic equipment". This product is designed to conform to AS/NZS 60598 "Luminaires, general requirements and tests".

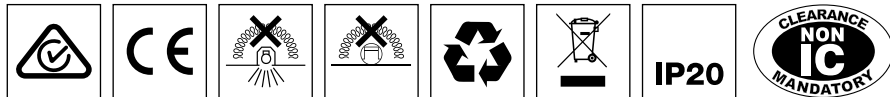

- 1** Isolate the mains power supply prior to commencing installation.

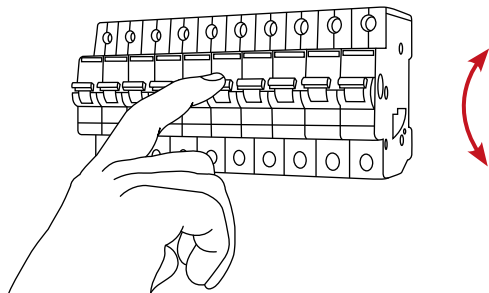

- 2** Mark at the correct location. Cut a hole in the ceiling in accordance with cutout size. XRS20 ceiling cutout: **120-130 mm**

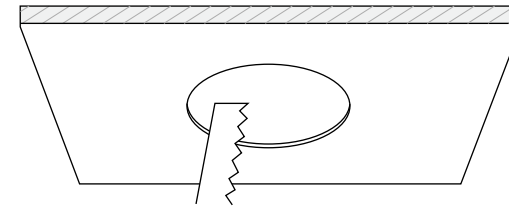

- 3** Connect luminaire to 240V plug socket.

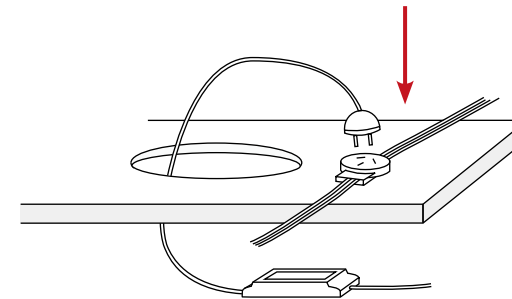

- 4** Lift the springs upward to ensure the luminaire can be installed into the mounting hole.

