



Scan to explore  
XPM90 online

# Maxipendant XPM90

80W High-powered Aluminium Dome Pendant

Product Code	Colour Temperature	Colour Technology	Beam Angle	Trim Colour	Driver
XPM90	3 (3000K)	(CRI 90+ Standard)	WB (Wide)	RW (Raw)	ND (Non-dimmable)
	4 (4000K)			CUS (Custom)	DALI (DALI)
	5 (5000K)				110V (1-10V)

Order Code **XPM904-WB-RW-ND**



To configure this pendant, please visit  
[trendlighting.com.au/product/maxipendant-XPM90](http://trendlighting.com.au/product/maxipendant-XPM90)

## Physical Characteristics

Trim Colour	Raw   Custom
Dimensions	Ø425 x 525 (H) mm
Weight	6250 g

## Dimensions (mm)

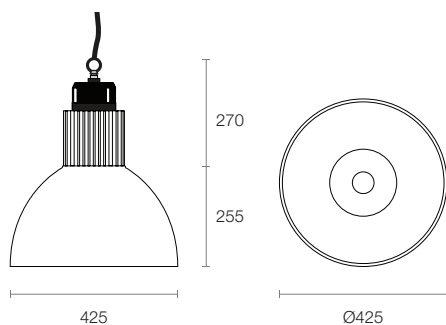

## Product Features

- Suspended high-powered LED pendant characterised by its industrial appearance and high light output
- Equipped with spun aluminium reflector and large passive heatsink, providing effective thermal management and ensuring high output and long lifespan
- CRI 90+ available in 3000K, 4000K and 5000K CCT options
- Supplied with a remote driver

## Product Attributes



## Technical Characteristics

Based on XPM904-WB-RW-ND

LED Power	80W
LED Type	COB
Lumen Output	10850 lm
Luminous Flux	7779 lm
Efficacy	81.03 lm/W
Colour Temperature	3000K   4000K   5000K
Colour Technology	CRI 90+
Colour Deviation	SDCM ≤ 3
Lifetime	50,000 hours (L80)
Beam Angle	Wide
System Power	96W Typical
Driver Model	Trend 150062 (Non-dim)
Input	220-240V AC 50/60 Hz
Output	60V DC 1500mA
Power Factor	>0.90
Protection	OVP, OTP, OCP, SCP, OPP
Dimming	Non-dimmable   DALI   1-10V

## General Characteristics

Category	Pendants
Family	Maxipendant
Surface	Ceiling
Mounting	Suspended
Ingress Protection	IP20