

5 Do not cover luminaire or driver with thermally insulating material **(A)**. It is recommended to allow a minimum of 50 mm clearance above the luminaire as seen in **(B)**.

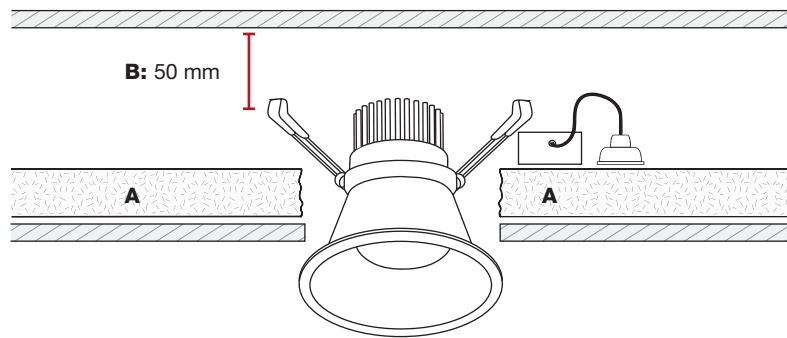

6 Restore power once installation has been completed.

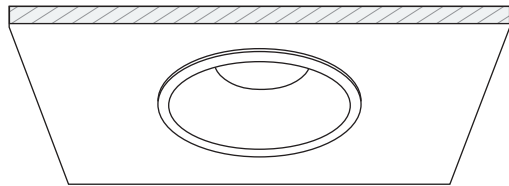

V1-01.04.2023 Product designs and technical data may be subject to change

Miniled XDTL10 Recessed Downlight *Installation Guide*

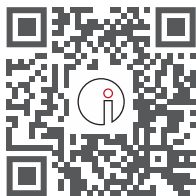
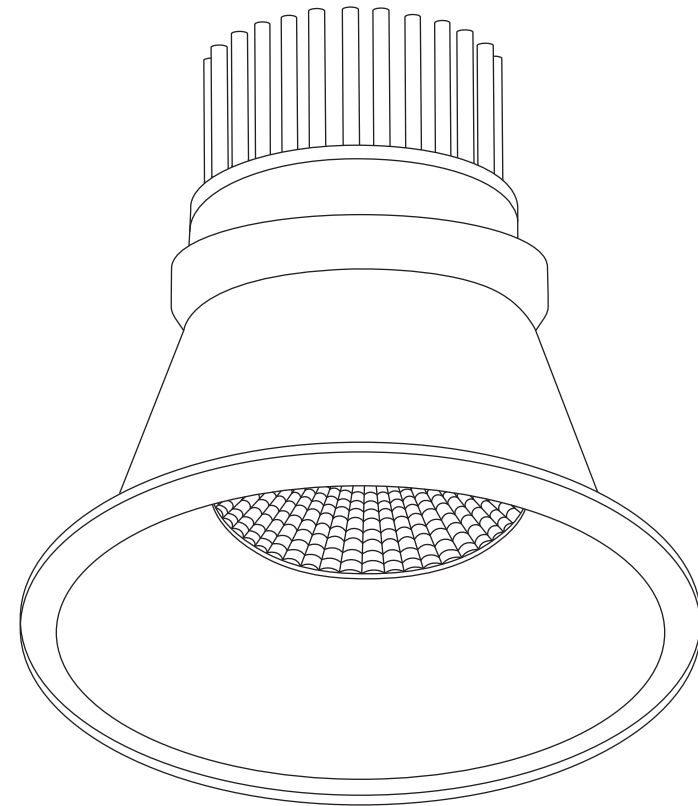

Miniled XDTL10

Trend Lighting Co. Pty Ltd



trendlighting.com.au

For warranty information, please visit

trendlighting.com.au/warranty

Important Safety Information

Please read these installation instructions carefully before installing this luminaire.

- This product must be installed by a licensed electrician in accordance with AS/NZS 3000 and local regulations.
- Isolate the mains power supply prior to installation.
- Only reconnect mains power after installation is completed.
- No part of the luminaire should be altered or modified.
- This product is not user serviceable.

Approvals

The RCM marking of this product applies to AS/NZS 4417.1 "Regulatory compliance mark (RCM) for electrical and electronic equipment". This product is designed to conform to AS/NZS 60598 "Luminaires, general requirements and tests".

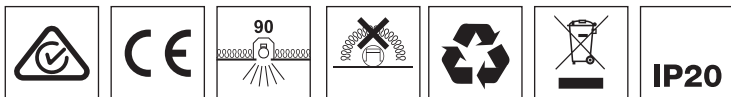

1 Isolate the mains power supply prior to commencing installation.

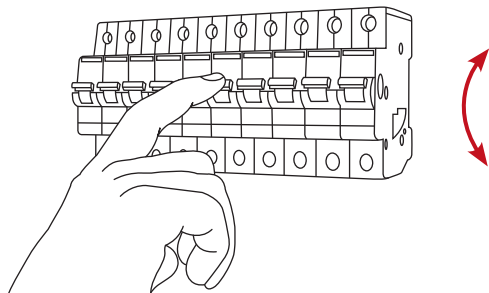

2 Mark at the correct location. Cut a hole in the ceiling in accordance with cutout size. XDTL10 ceiling cutout: **92 mm**

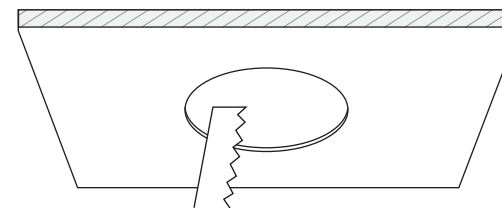

3 Connect luminaire to 240V plug socket.

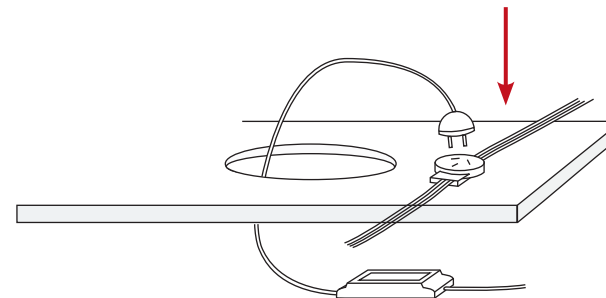

4 Lift the springs upward to ensure the luminaire can be installed into the mounting hole.

